

## ΤΕΧΝΙΚΕΣ ΛΕΠΤΟΜΕΡΕΙΕΣ / TECHNICAL DETAILS

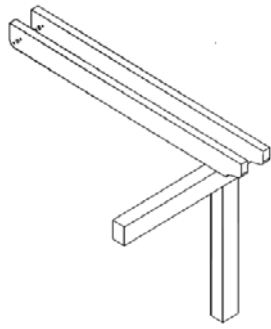

γρανάζια μοτέρ & οδηγών (αλουμινίου)  
aluminium cogwheel



προτεινόμενος τρόπος σκελετού  
intended fixing

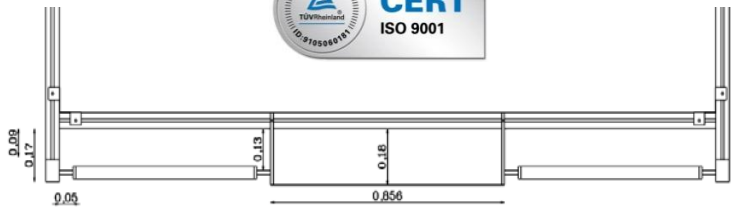

άξονας μετάδοσης κίνησης & Power Kit (μοτέρ)

Power Kit fixing



τάπα οδηγού  
guide end cap



ράουλο κίνησης  
wagon



τηλεσκοπικός άξονας  
octagon tube D40

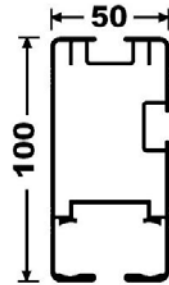

profil οδηγού / guide

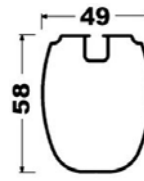

profil κόντρας  
middle bar profile

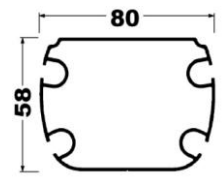

profil αντιβάρου  
bottom bar profile

## ΕΞΑΡΤΗΜΑΤΑ ΣΥΝΔΕΣΗΣ ΡΑΟΥΛΟΥ ΚΙΝΗΣΗΣ & profile ΚΟΝΤΡΑΣ - ΑΝΤΙΒΑΡΟΥ / MIDDLE BAR PARTS

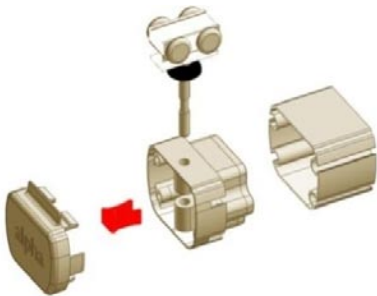

QUICK system

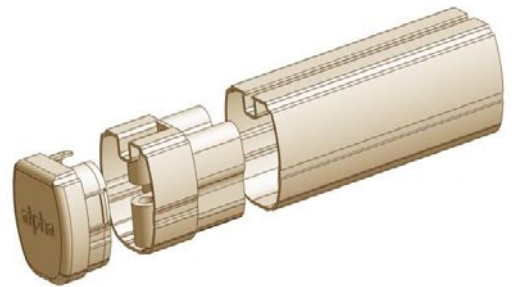

## ΤΥΠΟΙ ΒΑΣΕΩΝ ΣΤΗΡΙΞΗΣ ΟΔΗΓΟΥ ΣΥΣΤΗΜΑΤΟΣ SUPPORTS OF SIDE GUIDE

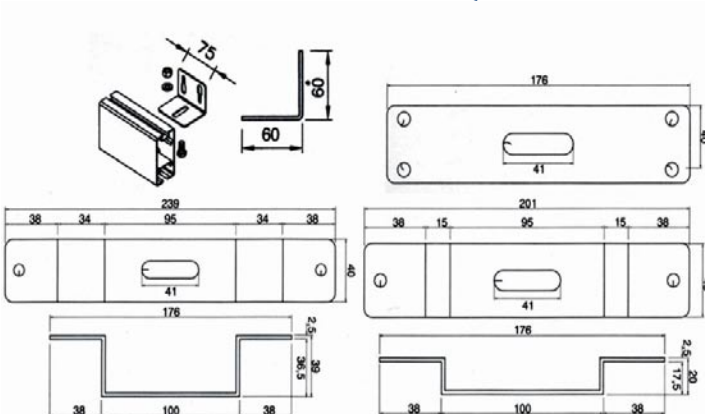

## ΒΟΗΘΗΤΙΚΑ ΣΤΟΙΧΕΙΑ / ADDITIONAL DETAILS

προβολή projection	κόντρες middle bar	αντίβαρα bottom bar	μάζεμα parking	κλίση inclination
έως 2,50μ	3	2	45cm	38cm
έως 3,00μ	4	2	50cm	45cm
έως 3,50μ	5	2	55cm	53cm
έως 4,00μ	6	2	60cm	60cm
έως 4,50μ	7	2	65cm	68cm
έως 5,00μ	8	2	70cm	75cm
έως 5,50μ	9	2	75cm	83cm
έως 6,00μ	10	2	80cm	90cm
έως 6,50μ	11	2	85cm	98cm
έως 7,00μ	12	2	90cm	105cm

ελάχιστη κλίση συστήματος / min inclination 15%